

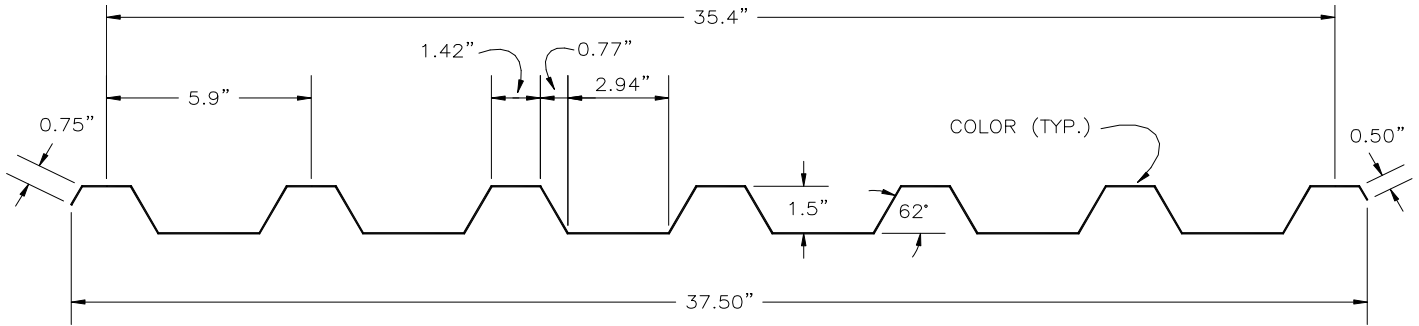

ARCHITECTURAL SYSTEMS, LLC

FLOLINE 900 PANEL



SECTION PROPERTIES						TOP IN COMPRESSION			BOTTOM IN COMPRESSION		
GAUGE	FY (KSI)	WEIGHT (PSF)	Vn kip/ft	REXn lbs/ft	RINn lbs/ft	Ix (in ⁴ /ft)	Sx (in ³ /ft)	Ma kip-in/ft	Ix (in ⁴ /ft)	Sx (in ³ /ft)	Ma kip-in/ft
24	50	1.33	2.161	577	895	0.1334	0.1443	4.33	0.1063	0.128	3.84

1. Section properties are calculated in accordance with the 2007 AISI North American Specification for the Design of Cold-Formed Structural Members.
2. Vn is the nominal web shear strength.
3. REXn is the nominal end-of-panel bearing strength (2" bearing)
4. RINn is the nominal panel bearing strength at interior supports (2" bearing)
5. Ix is Moment of Inertia for deflection determination
6. Sx is Section modulus for bending
7. Ma is the allowable bending moment
7. All values are for one foot of panel width

ALLOWABLE UNIFORM LOADS (PSF)

Span Type	Load Type	Span in Feet															
		1.50	2.00	2.50	3.00	3.50	4.00	4.50	5.00	5.50	6.00	6.50	7.00	7.50	8.00	8.50	9.00
Single	Positive Wind	769.12	576.84	461.47	320.71	235.62	180.40	142.54	115.45	95.42	80.18	68.32	58.91	51.31	45.10	39.95	35.63
	Negative Wind	769.12	576.84	409.60	284.45	208.98	160.00	126.42	102.40	84.63	71.11	60.59	52.25	45.51	40.00	35.43	31.61
	Live	769.12	576.84	461.47	320.71	235.62	180.40	142.54	115.45	95.42	80.18	68.32	58.91	51.31	45.10	39.95	35.63
	Deflection (L/180)	3703.83	1563.33	801.03	464.13	292.83	196.53	138.43	101.33	76.43	59.23	46.83	37.73	30.93	25.73	21.63	18.43
	Deflection (L/240)	2778.23	1172.83	601.13	348.43	219.93	147.73	104.13	76.33	57.63	44.73	35.43	28.63	23.53	19.63	16.63	14.23
Double	Positive Wind	477.41	358.06	286.45	238.71	204.60	160.00	126.42	102.40	84.63	71.11	60.59	52.25	45.51	40.00	35.43	31.61
	Negative Wind	477.41	358.06	286.45	238.71	204.60	179.03	142.54	115.45	95.42	80.18	68.32	58.91	51.31	45.10	39.95	35.63
	Live	477.41	358.06	286.45	238.71	204.60	160.00	126.42	102.40	84.63	71.11	60.59	52.25	45.51	40.00	35.43	31.61
	Deflection (L/180)	8920.13	3763.93	1927.83	1116.13	703.43	471.63	331.63	241.33	182.23	140.73	110.93	89.13	72.73	60.13	50.33	42.63
	Deflection (L/240)	6690.43	2823.33	1446.13	837.43	527.83	354.03	249.03	181.93	137.03	105.83	83.53	67.13	54.83	45.43	38.13	32.33
Triple	Positive Wind	542.51	406.88	325.51	271.26	232.51	200.00	158.03	128.00	105.79	88.89	75.74	65.31	56.89	50.00	44.29	39.51
	Negative Wind	542.51	406.88	325.51	271.26	232.51	203.44	178.17	144.32	119.27	100.22	85.40	73.63	64.14	56.37	49.94	44.54
	Live	542.51	406.88	325.51	271.26	232.51	200.00	158.03	128.00	105.79	88.89	75.74	65.31	56.89	50.00	44.29	39.51
	Deflection (L/180)	7008.63	2957.53	1514.93	877.23	552.93	370.83	260.83	190.53	143.43	110.83	87.43	70.23	57.43	47.53	39.83	33.73
	Deflection (L/240)	5256.83	2218.43	1136.53	658.23	415.03	278.43	195.93	143.23	107.93	83.43	65.93	53.03	43.33	35.93	30.23	25.63

Notes:

1. Allowable uniform loads are based upon equal span lengths.
2. Positive Wind is wind pressure and is **NOT** increased by 33 1/3%.
3. Negative Wind is wind suction or uplift and is **NOT** increased by 33 1/3%.
4. Live is the allowable live or snow load.
5. Deflection (L/180) is the allowable load that limits the panel's deflection to L/180 while under positive or live load.
6. Deflection (L/240) is the allowable load that limits the panel's deflection to L/240 while under positive or live load.
7. The weight of the panel has **NOT** been deducted from the allowable loads.
8. Positive Wind, Negative Wind and Live Load values are limited to combined shear & bending.
9. Positive Wind and Live Load values are limited by web crippling using a bearing length of 2" at end supports and 2" at interior supports